

Scope: EXcite USER MANUAL BPB 135			BARTEC TECHNOR		
Date: 24.11.2014	Rev.: A	Checked by: T.H.	Approved by: EGT	Page: Page 1 of 6	Document no.: 58-DSP-5

TECHNICAL MANUAL

EXPLOSION PROOF PUSH BUTTON

BPB 135

ATEX Marking:  II 2GD



Code: EPL Gb, Db

Ex d IIB+H2 T6 IP66

Ex tb IIIC T85°C



Marking details:

	
CE 0470  II 2 GD	Presafe 14ATEX 5387X IECEx PRE 14.0048X
Ex d IIB +H2 T6 Gb	IP66
Ex tb IIIC T85°C T.amb;-40°C<Ta<+70°C	U <input type="checkbox"/> VDC <input type="checkbox"/> AC 50/60Hz
Serial NO.:	
WARNING - DO NOT OPEN WHEN AN EXPLOSIVE ATMOSPHERE IS PRESENT	
BARTEC TECHNOR	
STAVANGER NORWAY	

Please note that every care has been taken to ensure the accuracy of our technical manual. We do not, however, accept responsibility for damage, loss or expense resulting from any error or omission. We reserve the right to make alterations in line with technical advances and industry standards.

Scope: EXcite USER MANUAL BPB 135			BARTEC TECHNOR		
Date: 24.11.2014	Rev.: A	Checked by: T.H.	Approved by: EGT	Page: Page 2 of 6	Document no.: 58-DSP-5

1.0 INTRODUCTION

BPB-135 series Explosion-proof Push Buttons is designed for use and installation in Zone 1 and Zone 2 areas with gases groups of IIA, IIB plus H2 and temperature classification of T6. It specially applies to Oil& Gas, Offshore Platform, Chemical, Petrochemical, Refinery and Marine Industries etc. Enclosure material is UV and corrosion resistance GRP (Glass Reinforced Polyester). The manual call point is convenient to use. The design of two LED indicators (Green and/or Red) is unique. It is compatible with PLC, DCS and ESD system via 4-20 mA output. It is ideal to be used as an explosion- proof Push Buttons for Fire Alarm System with Addressable Module fixed. There are four different types of manual call point available –the one with the red LED, green LED, both red and green LED and none.

Insert “√” before the one chosen by customer.

- With only red LED indicator-** During normal operation, the red LED will not be on unless the glass is broken by the operator when the device fault or alarm status arises.
- With only green LED indicator** – During normal operation, the green LED will be on unless the glass is broken by the operator when the device fault or alarm status arises.
- With both red and green LED indicator** - During normal operation, the Green LED is on. When device fault or alarm status arises, the Green LED will be cut off and Red LED will be on.
- No LED indicator

2.0 EXPLOSION-PROOF LABELING

All products have a rating label, which carries the following important information:

- Product order no.: e.g.
BPB135DLFABRD
(Refer to the datasheet for product order selection)
- Input voltage: <30 Vdc/ 6 amp or <250 Vac/ 11amp
- Code: Ex d IIB + H2 T6 Gb
Ex tb IIIC T85°C
- T.amb -40°C to +70°C
- ATEX Marking: Gas Group and Category: II 2GD
- CE Mark:  **CE** 0470
- Warning: DO NOT OPEN WHEN AN EXPLOSIVE GAS ATMOSPHERE IS PRESENT
- Finish product serial no. (Include date of construction)

Note; exact information is given on the actual label, ref also example on page 1.

Scope: EXcite USER MANUAL BPB 135					
Date:	Rev.:	Checked by:	Approved by:	Page:	Document no.:
24.11.2014	A	T.H.	EGT	Page 3 of 6	58-DSP-5

3.0 TYPE APPROVAL STANDARD

The BPB135 series products have an EC Type Examination Certificate issued by **DNV** and have been approved to the following standards:

IEC/ EN 60079-0 General Requirements

IEC/ EN 60079-1 Flameproof Enclosure “d”

IEC/ EN 60079-31 Dust atmosphere “t”

4.0 ZONES, GASGROUP, CATEGORY AND TEMPERATURE CLASSIFICATION

The BPB135 series products have been certified Ex d IIB+H2 T6. This means that the units can be installed in locations with the following conditions:

Area Classification:

Zone 1: Explosive gas air mixture likely to occur in normal operation.

Zone 2: Explosive gas air mixture not likely to occur, and if it does, it will only exist for a short time.

Gas Groupings: Group IIA Propane
Group IIB Ethylene Group + Hydrogen

Equipment Category: ATEX, 2GD

EPL: Gb / Db

Temperature Range: $-40\text{ }^{\circ}\text{C} < T_a < 70\text{ }^{\circ}\text{C}$

5.0 INSTALLATION

General Requirement

Selection, Installation, Maintenance and repair of electrical apparatus for use in potentially explosive atmosphere should be done in according to IEC/ EN 6079-14/ -17/ -19. Product installation must be carried out in accordance with any local codes that may apply and should only be carried out by a competent electrical engineer.

Location

The location of the unit should be made with due regard to the area where the unit is visible and can be easily operated. The unit should only be fixed to services that can carry the weight of the unit.

Scope: EXcite USER MANUAL BPB 135					
Date:	Rev.:	Checked by:	Approved by:	Page:	Document no.:
24.11.2014	A	T.H.	EGT	Page 4 of 6	58-DSP-5

Mounting

The product should be mounted on a vertical surface using two (2) fixing holes in the base by removing the end cover. The fixing holes are designed to fit M5 Allen Screw only. Use of stainless steel fastener is recommended by BARTEC TECHNOR. If you need mounting plate, please contact BARTEC TECHNOR to ask the installation drawing of the mounting plate. (See Fig 1)

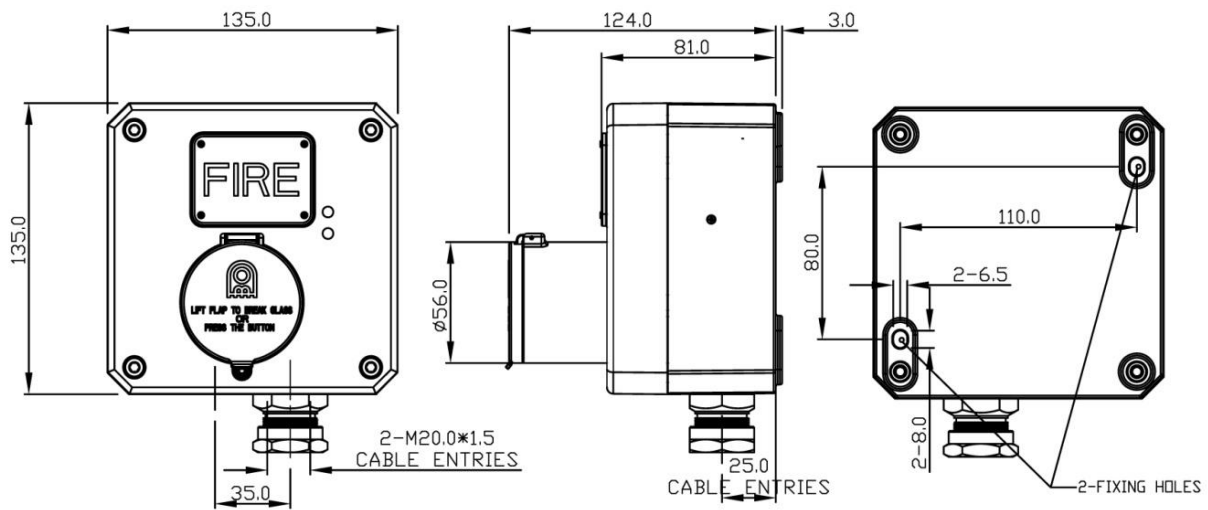

Fig. 1

6.0 WIRING

General Requirement

BARTEC TECHNOR recommends that all cables and cores should be fully identified (suggest using cable from 2.0 to 2.5 mm²). Ensure that all nuts, bolts and screws are secured. Ensure that only the right and certified cable glands are used and earthed correctly. Ensure that only the right and certified stopping plugs are used to blank off unused gland entry points. In order to maintain the IP rating of the product, we recommend SS316L for this application.

Cable Connection

The cable connection is connected with the 8-hole terminal blocks marked T1-T8 located in the flameproof enclosure (See Fig 2). Cable connection should be carried out in accordance with relevant technical requirement.

Remove End Cover

Unscrew the four (4) M5 retained hex socket head screws. This will release the cover from the base and allow the cover to hang on the retaining wire strap. Before replacing the cover, check that the flameproof joints are clean and not damaged, the gasket is still retained in its groove. (See Fig 2)

CAUTION: Before removing the cover, ensure the power to the product is isolated. Remove the four pieces of M5 socket screws to open the cover. Twist the cover gently clockwise and anti-clockwise, whilst pulling away from the base, until it comes off. Replace the cover in similar way, but operate in reverse manner as above.

Scope:

EXcite

USER MANUAL
BPB 135

BARTEC **TECHNOR**

Date:

24.11.2014

Rev.:

A

Checked by:

T.H.

Approved by:

EGT

Page:

Page 5 of 6

Document no.:

58-DSP-5

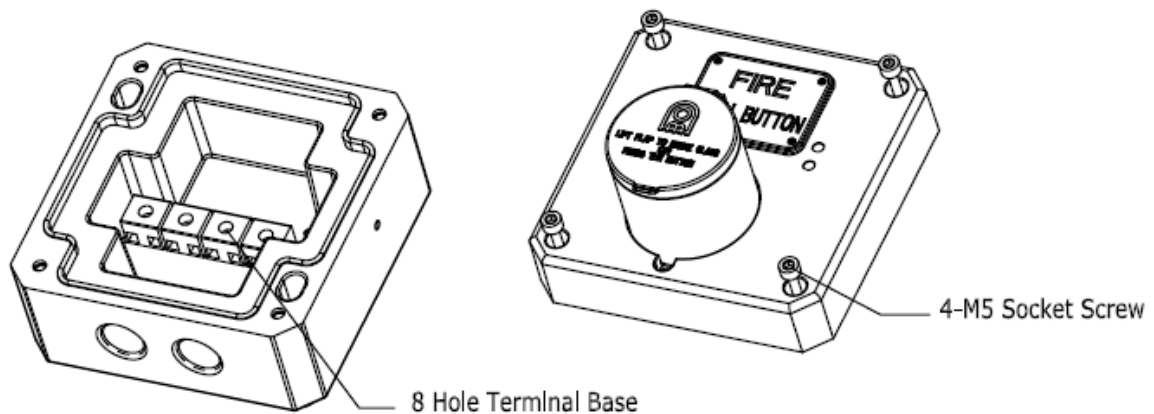

Fig. 2

7.0 OPERATION

There are two types of Push Button available- with or without flap. The product is operated by pushing the button. Simply lift up the flap if it comes with it.

Key Reset

Users may need to reset the unit with the key facility. Insert the key into the key hole located in the centre of the button. Turn the key clockwise 90° and pull the button slightly. Turn the key anticlockwise 90° after the button is reset. (See Fig 3)

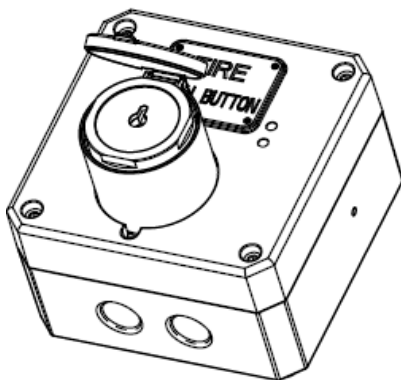

Fig 3

Scope: EXcite USER MANUAL BPB 135					
Date:	Rev.:	Checked by:	Approved by:	Page:	Document no.:
24.11.2014	A	T.H.	EGT	Page 6 of 6	58-DSP-5

8.0 CABLE GLAND

The BPB135 series product has two (2) cable gland entries. Only cable glands approved for Ex 'd' applications can be used, which must be suitable for the type of cable being used and also meet the requirements of the Ex 'd' flameproof installation standard EN 60079-14.

SAFETY WARNING: If the BPB135 is used at high ambient temperatures, i.e. over +40°C, then the cable entry temperature may exceed +70°C and therefore suitable heat resisting cable glands must be used, with a rated service temperature of at least 95°C. If a high IP (Ingress Protection) rating is required, a suitable sealing washer must be fitted under the cable gland. When only one cable entry is used, the other one must be closed with an Ex 'd' flameproof blanking plug, which must be suitably approved for the installation requirements.

9.0 END OF LINE MONITORING

An end of line monitoring diode or an end of line monitoring resistor can be connected across the 24V+ and 0 terminals. If an end of line monitoring resistor is used, it must have a maximum resistance value of 3k ohms and a minimum wattage of 0.5 Watts; or a minimum resistance value of 1.2k ohms and a maximum wattage of 2 Watts.

10.0 MAINTENANCE

During working life of the product, little or no maintenance is required. GRP are resistant to most of the acids, alkalis and chemicals. If abnormal or unusual environmental conditions occur due to accident etc., visual inspection is recommended.

As to avoid electrostatic charge build-up, only exterior of the product can be cleaned with a damp cloth. If spare parts are required, these can be supplied by BARTEC TECHNOR.

SAFETY WARNING: In the case of Anti Static and UV Resistant GPR, the painting of the enclosure surface has been processed specially. To maintain the product to be Anti Static, extra normal painting is not allowed.

If any failure occurs but not cause by human factor, the product can be returned to BARTEC TECHNOR for free repair or replacement during warranty period.

11.0 CONDITIONS FOR SAFETY USE

- i. This apparatus is suitable to be used only in ambient temperature as stated below:
- ii. Other than product manufacturer, painting and surface finishing are not permitted by the third party.
- iii. When used in dusty atmosphere, flameproof cable entry devices or stopping plugs have to be selected and installed carefully in order to maintain the IP rating (IP66) of the product.

Type	Ambient Temp.
PB-135	-40 to +70 °C