



### Note on instructions

When working in hazardous areas, the safety of personnel and equipment depends on compliance with the relevant safety regulations. The people in charge of installation and maintenance bear a special responsibility. It is essential that they have an exact knowledge of the applicable rules and regulations.

The instructions provide a summary of the most important safety measures and must be read by everyone working with the product so that they will be familiar with the correct handling of the product.

The instructions have to be kept for future reference and must be available throughout the expected life of the product.

### Description

The junction box with cable gland is designed for combining with various function modules. Selection chart, see page 3.

Two screws are used to connect the junction box to the respective function module.

The junction box allows a conductor to be connected, which can be assembled either to order or by the customer.

### Explosion protection

#### Ex type of protection

Function module with junction box

Ex II 2G

Ex db eb IIC T6 Gb

Ex II 2D

Ex tb IIIC T80 °C Db IP66

#### Certification

Function module with junction box

CML 17 ATEX 1117 X

IECEX CML 17.0055X

#### Ambient temperature ranges

-55 °C to +40 °C/+50 °C/+60 °C  
(-67 °F to 104 °F/+122 °F/140 °F)

Depends on the function module; observe the specifications on the type label

#### Approved for zones

1, 2 and 21, 22

### Technical data

#### Protection class

Function module with junction box and actuating element: Up to IP66/IP67

#### Weight

Approx. 40 g (0.09 lb)

#### Electrical parameters

See operational instruction of the respective function module

#### Cable gland clamping range

- 4 to 9 mm (0.16 to 0.35 in)
- 5 to 10 mm (0.2 to 0.39 in)

#### Enclosure material

Thermoplastic

#### Mounting

Screwed to the function module

### Dimensions in mm (in)

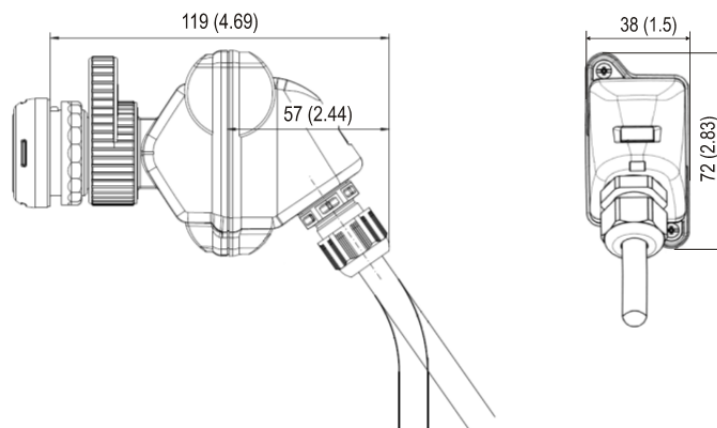

#### Note

Observe the minimum bending radii of the inserted cables.

## Safety Instructions

Junction box, function module, and the corresponding actuating element may be used only within the specified ambient and operating temperature range. Incorrect installation can cause malfunctioning and the loss of explosion protection.

Utilization in areas other than those specified or the modification of the product by anyone other than the manufacturer is not permitted and will exempt BARTEC from liability for defects and any further liability.

The generally applicable statutory rules and other binding directives relating to workplace safety, accident prevention and environmental protection must be observed.

When setting up or operating explosion-resistant electrical systems, the IEC/EN 60079-14 (NEC for USA/CEC for Canada) and all relevant installation and operating regulations must be observed.

The junction box may be used only if it is in a clean and undamaged condition. It is not permissible to modify the junction box in any way.

## Marking

Particularly important points in these instructions are marked with a symbol:

### DANGER

DANGER indicates a hazardous situation which, if not avoided, will result in death or serious injury.

### WARNING

WARNING indicates a hazardous situation which, if not avoided, could result in death or serious injury.

### CAUTION

CAUTION indicates a hazardous situation which, if not avoided, could result in minor or moderate injury.

### NOTICE

NOTICE is used to address practices not related to personal injury.

### Note

Important instructions and information on effective, economical and environmentally compatible handling.

## Standards conformed to

EN 60079-0:2012+A11:2013  
EN 60079-1:2014  
EN 60079-7:2015  
EN 60079-31:2014  
IEC 60079-0:2011  
IEC 60079-1:2014-06  
IEC 60079-7:2015  
IEC 60079-31:2013  
DIN EN 60068-2-27:2010, 30 g, 18 ms

## Transport, Storage

### NOTICE

Junction box damage through incorrect transport or incorrect storage.

- Transport and storage is permissible in original packaging only.

## Assembly, Installation, and Commissioning

### WARNING

Risk of serious injury due to incorrect proceedings.

- Only authorized and qualified personnel may do any of the assembly, disassembly, installation and commissioning work.
- Install the junction box as a stationary unit and protected it against the risk of mechanical damage as well as the risk of electrostatic charge.
- Install cable firmly.
- Use suitable tools.
- The temperature range of the conductor could reduce the temperature range of the product. Example: Conductor, -20 °C (-4 °F), → max. ambient temperature of the product, -20 °C (-4 °F).

## Assembly/disassembly

### NOTICE

Property damage due to incorrect tightening torques.

- Loose or excessive tightening of the thread or the cap nut can affect the type of protection, the density, or the strain relief. The tightening torques are dependent on the cables and conductors used. They have to be determined by the operator. The cable gland and the cap nut have to be tightened firmly.

### Note

The switch module in the sketch serves as an example of all function modules.

Mounting the junction box:

- Make sure the junction box and the sealings to be fitted are intact (no cracks).

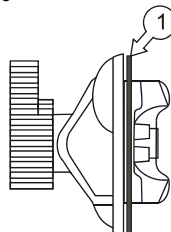

- Put the sealing (1) with the round side facing downwards into the circumferential groove.
- Strip approx. 40 mm (1.58 in) from the length of the conductor and remove approx. 6 mm (0.24 in) conductor insulation from the cores.

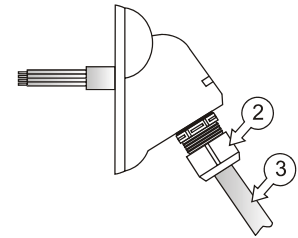

- Open the cap nut (2) far enough to allow the conductor to be inserted.
- Feed the conductor (3) into the cable gland on the junction box until there is sufficient length available for preparing the conductor connection.
- Close the cap nut (2).

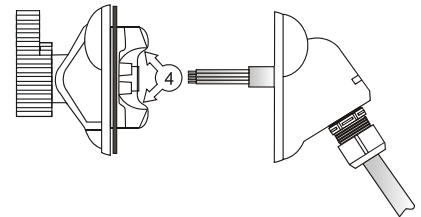

- Connect the conductors (4).

### Note

The conductor connection and the terminal assignment for the individual function modules are described in the operating instructions for each function module.

- Push the junction box firmly onto the function module.

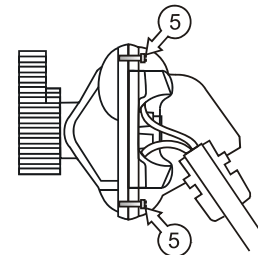

- Tight the screws (5). Torque 0,5 – 0,6 Nm (0,36-0,44 lb.ft).

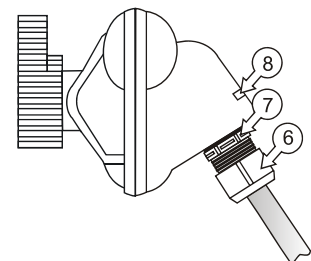

- Tighten the cap nut (6) 1,3 Nm (0,96 lb.ft) (fixing nut (7), max. torque 2.0 Nm (1.46 lb.ft).
- Open the clip to take out the label (8), write on it and put it back in again.

## Commissioning

Before commissioning, check that:

- The entire device has been installed in compliance with regulations.
- The entire device is not damaged.
- The connection has been established properly.

## Maintenance and Fault Clearance

### WARNING

Risk of serious injury due to incorrect proceedings.

- Only authorized qualified personnel may do any of the work relating to maintenance and fault clearance.
- IEC/EN 60079-17 must be observed.

The operator of the junction box must keep it in good condition, operate it properly, monitor it and clean it regularly.

## Maintenance

### WARNING

Risk of serious accidents due to damaged parts.

- Check junction boxes, screw fittings, sealings, and cables regularly for cracks and damage. Make sure that they are properly established.

### NOTICE

Junction box damage due to incorrect cleaning.

- It is not allowed to clean dirty junction boxes with compressed air.

## Fault Clearance

### WARNING

Risk of serious injury due to use of non-original spare parts.

- Use original parts only as replacements.

The junction boxes are defective if they have cracks or other damage or if the cable no longer fits absolutely securely.

Defective junction boxes cannot be repaired; They must be replaced considering this operational instruction.

## Accessories, Spare Parts

For further accessories and spare parts, see BARTEC catalogue.

## Disposal

The components in the function module contain metal and plastic parts.

Therefore the statutory requirements for disposing of electronic scrap must be observed (e.g. disposal by an approved disposal company).



## Service Address

BARTEC GmbH  
Max-Eyth-Straße 16  
97980 Bad Mergentheim  
Germany  
Tel.: +49 7931 597-0  
Fax: +49 7931 597-119

## Selection chart

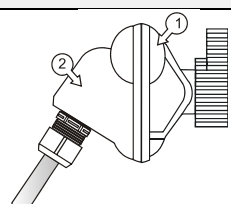
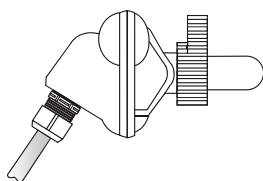
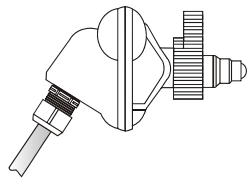
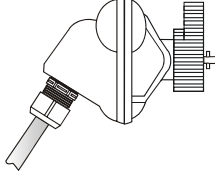
Illustration	Description and type/order number
	Switch module with junction box      type number 07-3323-5.../....  Switch module (1)      type number 07-3323-4.../.... Junction box (2)      order number 05-0042-0050
	Lamp module with junction box      type number 07-3353-5.../....  Lamp module      type number 07-3353-4.../.... Junction box (2)      order number 05-0042-0050
	Illuminated button with junction box      type number 07-3363-5.../....  Illuminated button      type number 07-3363-4.../.... Junction box (2)      order number 05-0042-0050
	Potentiometer with junction box      type number 07-3373-5.../....  Potentiometer      type number 07-3373-4.../.... Junction box (2)      order number 05-0042-0050

EU Konformitätserklärung  
EU Declaration of Conformity  
Déclaration UE de conformité**BARTEC**BARTEC GmbH  
Max-Eyth-Straße 16  
97980 Bad Mergentheim  
Germany

N° 01-3300-7C0001\_B

Wir	We	Nous
-----	----	------

**BARTEC GmbH,**

erklären in alleiniger Verantwortung, dass das Produkt <b>Steuer-, Schalt- und Anzeigemodul</b>	declare under our sole responsibility that the product <b>Control, Switching and Display Module</b>	attestons sous notre seule responsabilité que le produit <b>Commande, commutation et module afficheur</b>
---	---	---

**Typ 07-33\*3-5\*\*\*/\***

auf das sich diese Erklärung bezieht den Anforderungen der folgenden <b>Richtlinien (RL)</b> entspricht <b>ATEX-Richtlinie 2014/34/EU</b> <b>EMV-Richtlinie 2014/30/EU</b> <b>RoHS-Richtlinie 2011/65/EU</b> <b>WEEE-Richtlinie 2012/19/EU</b> und mit folgenden Normen oder normativen Dokumenten übereinstimmt	to which this declaration relates is in accordance with the provision of the following <b>directives (D)</b> <b>ATEX-Directive 2014/34/EU</b> <b>EMC-Directive 2014/30/EU</b> <b>RoHS-Directive 2011/65/EU</b> <b>WEEE-Directive 2012/19/EU</b> and is in conformity with the following standards or other normative documents	se référant à cette attestation correspond aux dispositions des <b>directives (D)</b> suivantes <b>Directive ATEX 2014/34/UE</b> <b>Directive CEM 2014/30/UE</b> <b>Directive RoHS 2011/65/UE</b> <b>Directive WEEE 2012/19/UE</b> et est conforme aux normes ou documents normatifs ci-dessous
---	---	--

**EN 60079-0:2012 + A11:2013****EN 60079-1:2014****EN 60079-7:2015****EN 60079-11:2012****EN 60079-31 :2014**

<b>Verfahren der EU-Baumusterprüfung / Benannte Stelle</b>	<b>Procedure of EU-Type Examination / Notified Body</b>	<b>Procédure d'examen UE de type / Organisme Notifié</b>
--	---	--

**CML 17ATEX1117X****2276, CML B.V., Hoogoorddreef 15, 1101BA Amsterdam, NL****CE 0044**

Bad Mergentheim, 25.04.2019

  
i.A. Jan Kirschner  
Global Product Line Manager  
Ex e

  
i.V. Cristian Olaru  
Team Leader Certification Center