



- Temperature-resistant
- Flame-retardant
- For use in hazardous areas with surface resistance <math>< 10^9 \Omega</math>
- Absolutely corrosion-proof
- Seawater-proof

Polyester enclosures have proven their worth in many industrial plants. They offer safe protection even when they are used under extremely unfavorable conditions, on exposure to aggressive chemical media or hard mechanical conditions. The inside base of the enclosure has at its sides, threaded bushings for the fastening of mounting rails or panels. The enclosure is mounted by means of insulated screws outside of the lid seal.

Explosion protection

Marking	Ⓜ II 2G Ex e IIC T6, T5 Gb Ⓜ II 2D Ex tb IIIC T80 °C, T95 °C Db
Certification	PTB 08 ATEX 1064 IECEx PTB 09.0009X
Other approvals and certificates, see www.bartec.de	

Technical data

Material	glass-fiber reinforced polyester, surface resistance <math>< 10^9 \Omega</math>
Colour	RAL 9005, black
Mechanical resistance	impact energy 7 Nm
Protection class (EN 60529/IEC 60529)	IP 66/67
Cable gland	IP 65
Supply voltage	500 V/690 V (depending on version)
Ambient temperature range	EPDM: -20 °C to +40 °C (T6) silicone: -55 °C to +40 °C (T6) or -55 °C to +55 °C (T5)
Lid screws	Stainless steel cross slot (+ -)

Ordering information Enclosure

Short form title	Enclosure sizes (mm)	Qty/ Terminal sizes	Terminal identification	Qty/Earth terminals	Glands per enclosure	Terminal range	Order no.
Ex 300	160 x 160 x 90	2/6 mm ²	L, N	2/6 mm ²	1 x M25 2 x threaded M20	∅ 7 to 17 mm	07-5103-9054
Ex 400 S	160 x 160 x 90	3/6 mm ²	L1; L2, L3	4/6 mm ²	1 x M25 4 x threaded M20	∅ 7 to 17 mm	07-5103-9055
Ex 400 D	260 x 160 x 90	6/6 mm ²	2 x L1; 2 x L2; 2 x L3	je 6/6 mm ²	1 x M25 6 x threaded M20	∅ 7 to 17 mm	07-5103-9056
Ex 690	160 x 160 x 90	2/16 mm ²	L, N	2/16 mm ²	1 x M40 2 x threaded M20	∅ 17 to 28 mm	07-5103-9219
Ex 690 S/D	260 x 160 x 90	7/16 mm ²	2 x L1; 2 x L2; 2 x L3	6/16 mm ²	1 x M40 6 x threaded M20	∅ 17 to 28 mm	07-5103-9220

Technical data subject to change without notice.

Junction box Ex 300

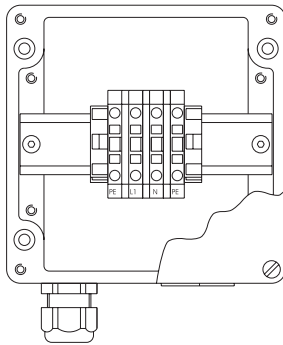

Connection diagram for junction box Ex 300

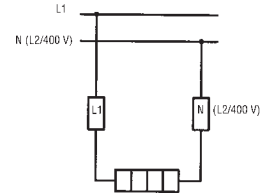

Junction box/terminal box Ex 400 S

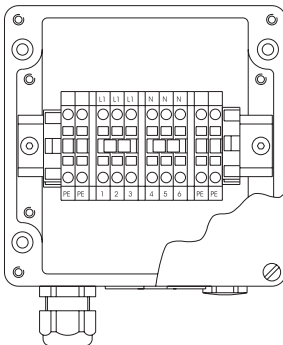

Connection diagram for junction box Ex 400 S

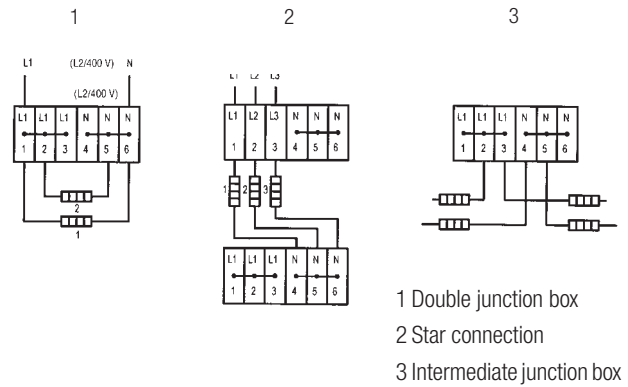

Junction box Ex 400 D

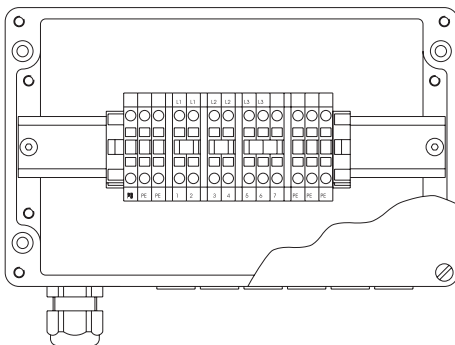

Connection diagram for junction box Ex 400 D

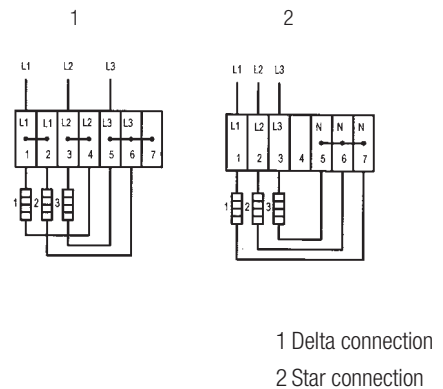

1

Junction box Ex 690

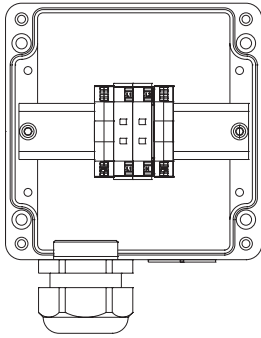

Connection diagram for junction box Ex 690

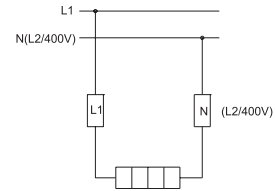

Junction box/terminal box Ex 690 S/D

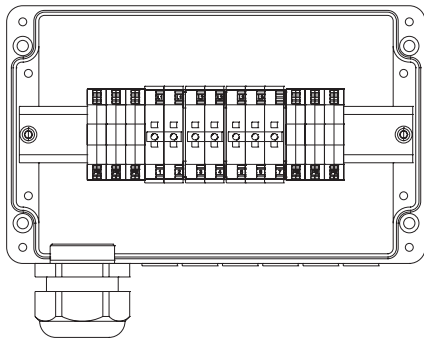

Connection diagram for junction box Ex 690 S/D

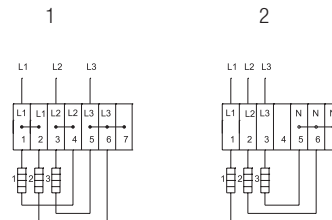

1 Delta connection
2 Star connection